

Low-Intermediate
A 15cm (6 inch) square makes a 5cm (2 inch) wide model.

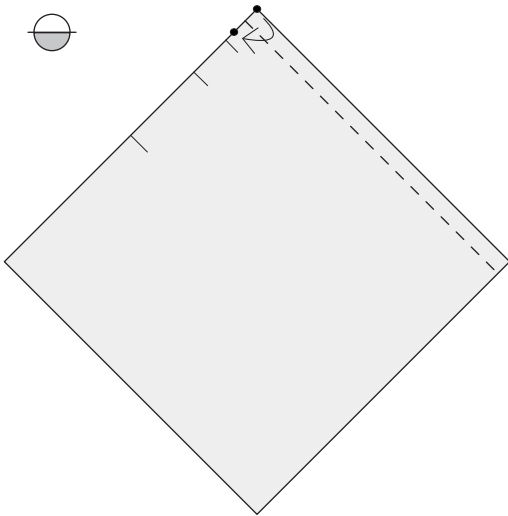

1. Start with a square, white side up. Fold edge just short of the 1/8 mark.

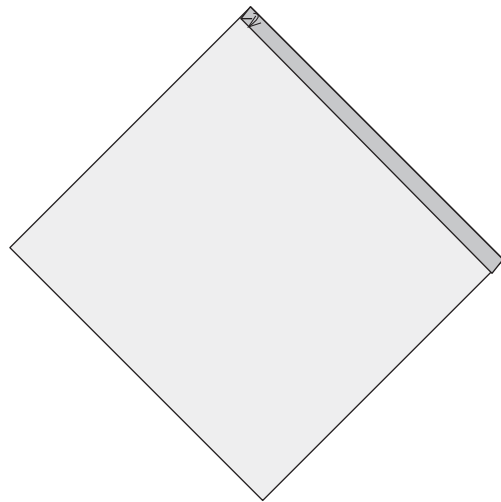

2. Valley-fold tip.

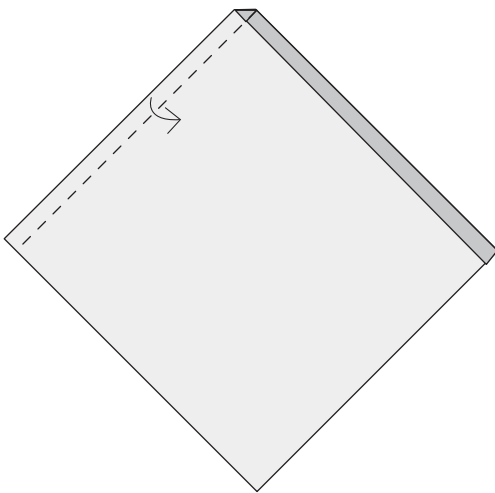

3. Valley-fold edge.

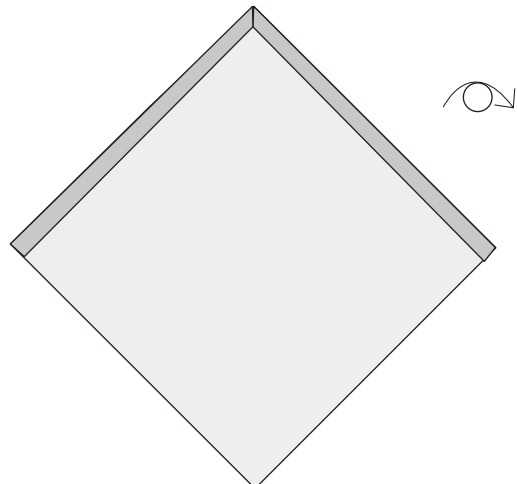

4. Turn over.

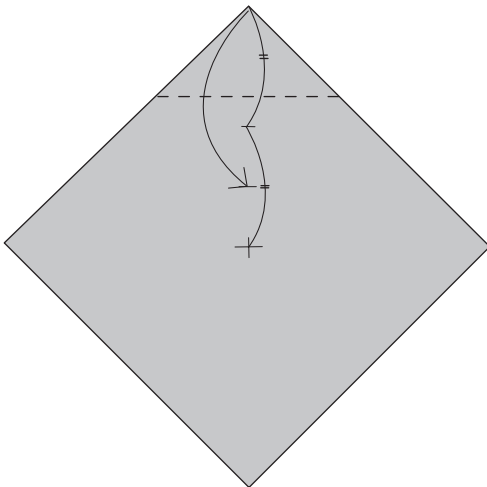

5. Valley-fold tip to the 3/4 mark.

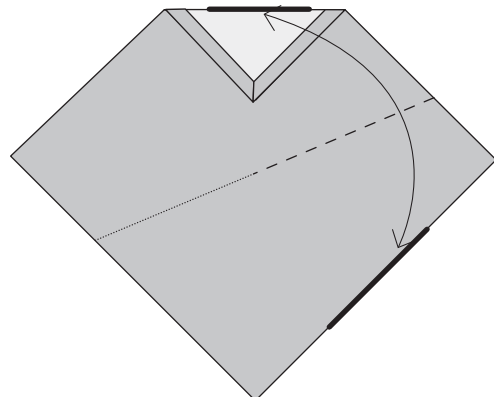

6. Fold bottom-right edge to top edge, creasing only where noted. Unfold.

Gmail (Page 2)

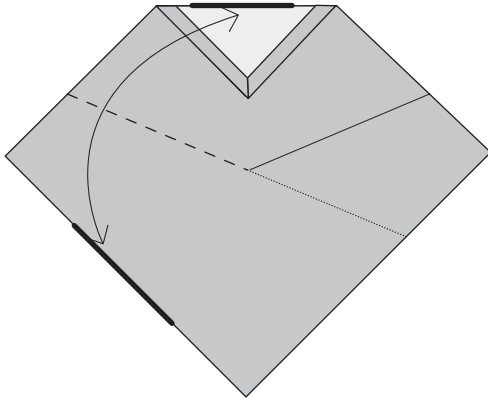

7. Repeat on left edge.

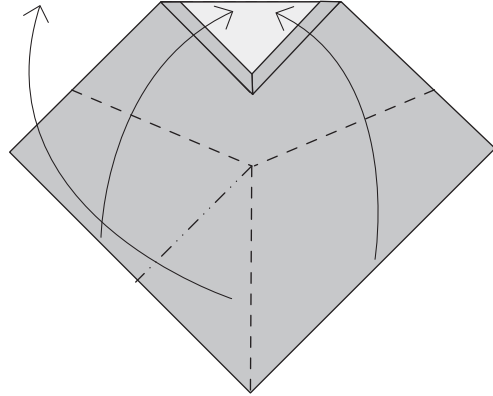

8. Bring the two edges to the top. This is a Rabbit-ear fold.

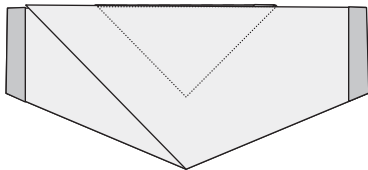

9. Bring small triangle to the front.

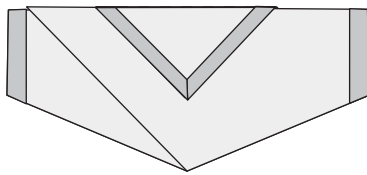

10. Turn over.

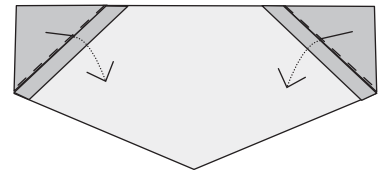

11. Fold corners into pockets.

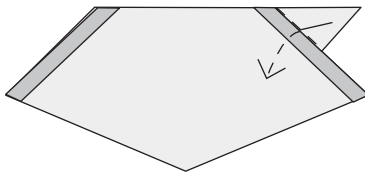

12. Tuck into pocket.

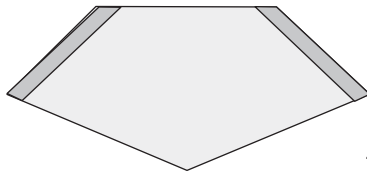

13. Turn over.

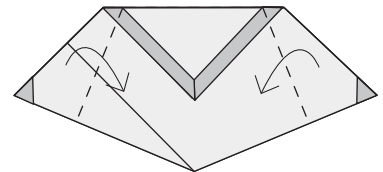

14. Valley-folds.

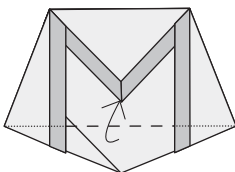

15. Tuck flap under point.

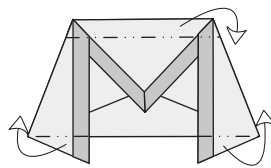

16. Mountain-fold top and corners.

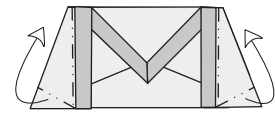

17. Mountain-fold sides to make a stand.

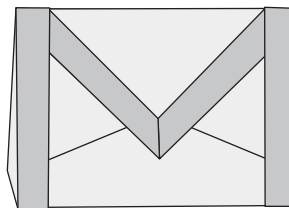

Gmail ready!