

Flag of The Czech Republic

© Gilad Aharoni (Israel / MA) 2008

Simple
Two 15cm (6 inch) squares make a 9cm (3.5 inch) wide model.

 Part1

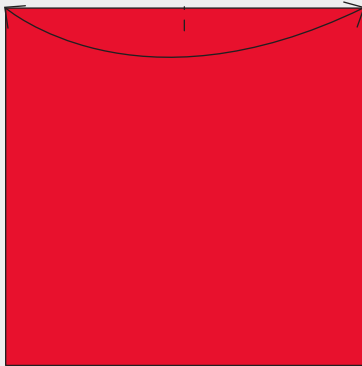

1. Mark center with a tiny crease.

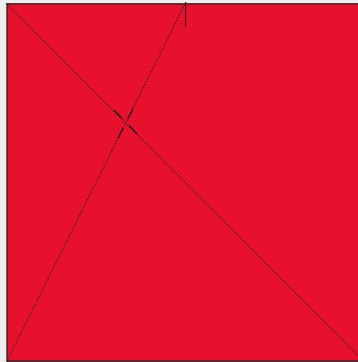

2. Add 2 very light creases, marking their intersection.

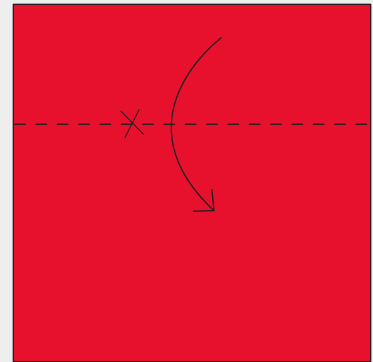

3. Valley-fold down.

 Part 2



Part1

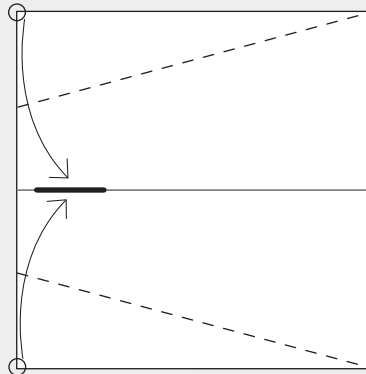

4. Valley-fold so left corners touch the center line.

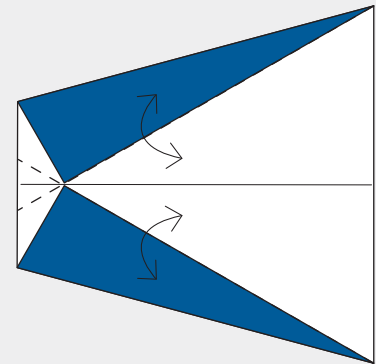

5. Fold and unfold.

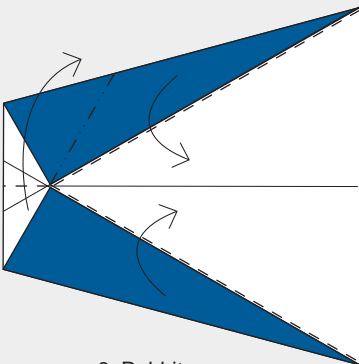

6. Rabbit-ear.

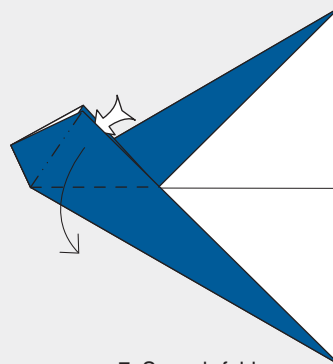

7. Squash-fold.

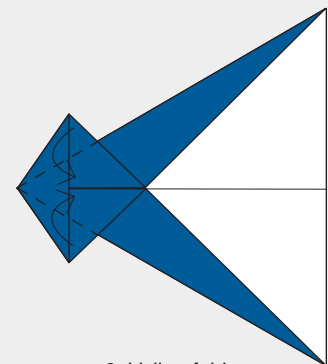

8. Valley-folds.

Flag of The Czech Republic (Page 2)

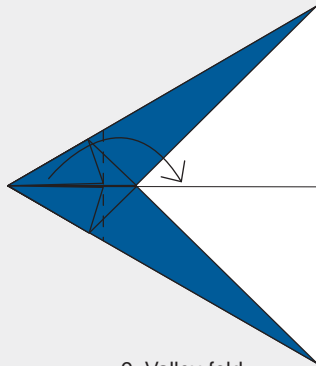

9. Valley-fold.

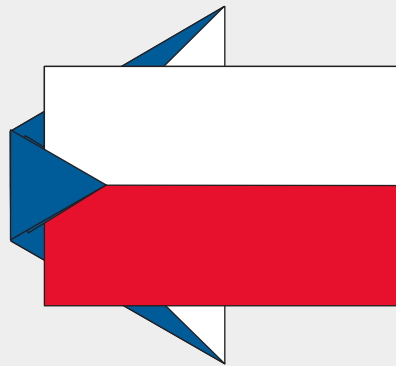

10. Slide part 1 into part 2.
White flap goes inside pocket.

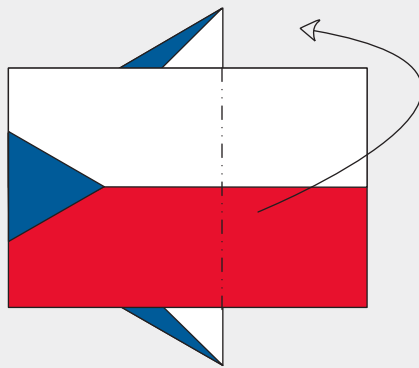

11. Mountain-fold.

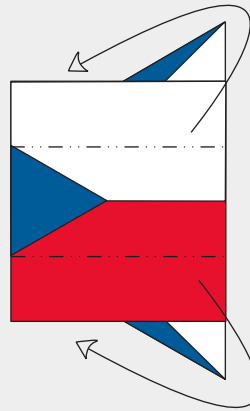

12. Mountain-folds.

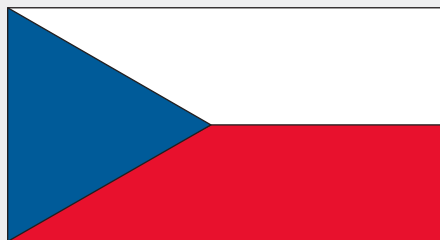

Flag of the Czech Republic